





PROJECT:	_____
LOCATION:	_____
ITEM#:	_____
QUANTITY:	_____

COMPETITOR SERIES®

UNDER-COUNTER/WORK TOP REFRIGERATORS

- Beautiful ergonomic construction & rounded corners
- Digital Controller with Temperature Read-out
- All stainless steel exterior and interior
- Forced air refrigeration system
- Recessed door handles
- Pre-installed casters and shelving
- 90 degree hold open door feature for loading products
- Optional Accessory: Backsplash for Work-Tops for in-the-field installment
- All Natural R290 Hydrocarbon Refrigerant
- US Department of Energy Certified
- Migali® Protection Plan: 1 Year Parts & Labor Warranty, 5 Years Compressor Warranty

MODEL	DOORS	CAPACITY CU/FT	SHELVES	H/P	AMPS	VOLTAGE	ENERGY CONSUMPTION KWH/24 HR	PLUG TYPE	TEMP RANGE	EXTERIOR DIMENSIONS W X D X H*	INSIDE DIMENSIONS W X D X H	PACKAGED DIMENSIONS W X D X H	WEIGHT	PACKAGED WEIGHT
C-U27R-HC	1	6.5	1	1/4	2.5	115/60/1	0.83	 Nema 5-15P	+33° F (~) +41° F	27.5" x 30" x 37.25"	23.9" x 23.6" x 26.7"	29" x 32" x 39"	151 lbs.	164 lbs.
C-U48R-HC	2	12	2	1/3	3.6	115/60/1	1	 Nema 5-15P	+33° F (~) +41° F	48.2" x 30" x 37.25"	44.7" x 23.6" x 26.7"	50" x 32" x 39"	212 lbs.	236 lbs.
C-U60R-HC	2	18.2	2	1/2	3.6	115/60/1	1.2	 Nema 5-15P	+33° F (~) +41° F	60.2" x 30" x 37.25"	56.7" x 23.6" x 26.7"	63" x 32" x 39"	245 lbs.	266 lbs.
C-U72R-HC	3	24.5	3	1/2	3.6	115/60/1	1.3	 Nema 5-15P	+33° F (~) +41° F	72.7" x 30" x 37.25"	56.7" x 23.6" x 26.7"	74" x 32" x 39"	283 lbs.	301 lbs.

* Total height includes casters

Accessories: Stainless Steel Back Splash - BS27 - 27" wide / BS48 - 48" wide / BS60 - 60" wide / BS72 - 72" wide

NOTE: MIGALI® RESERVES THE RIGHT TO CHANGE SPECIFICATIONS WITHOUT NOTICE

DIMENSIONAL DRAWINGS

C-U27R-HC

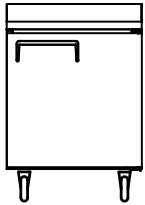

C-U48R-HC

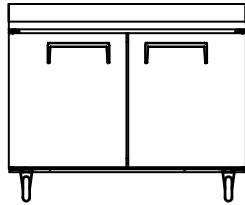

C-U60R-HC

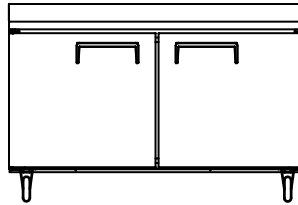

C-U72R-HC

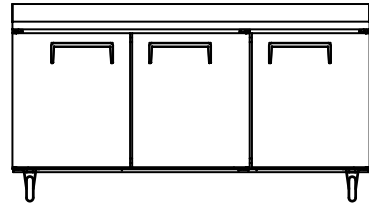

C-U27R-HC
TOP VIEW

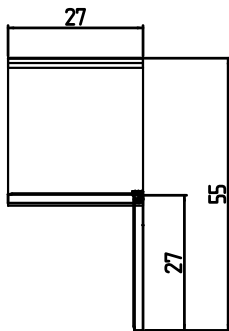

C-U48R-HC
TOP VIEW

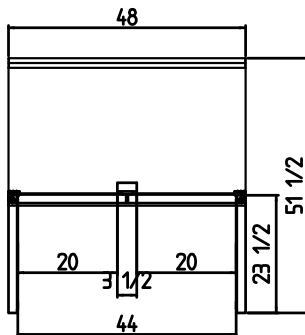

C-U60R-HC
TOP VIEW

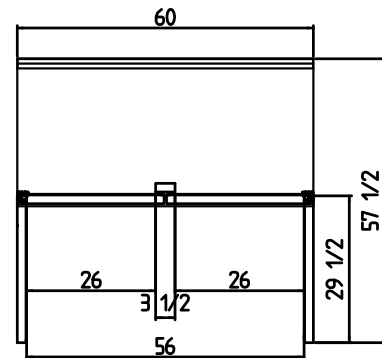

C-U72R-HC
TOP VIEW

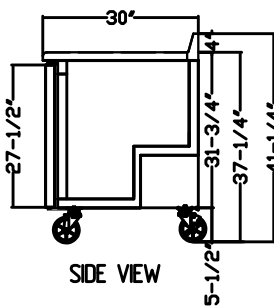
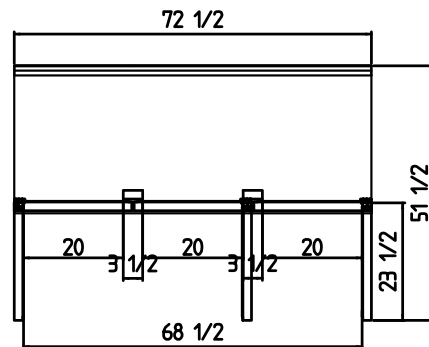

SIDE VIEW

SIDE VIEW (1,2,3) DOORS MODELS



Migali[®]

MIGALI[®] REMAINS AN AMERICAN FAMILY COMPANY SINCE 1955