

PROJECT:	_____
LOCATION:	_____
ITEM#:	_____
QUANTITY:	_____

COMPETITOR SERIES®

C-DD23-1-HC

C-DD48-2-HC

C-DD60-2-HC

C-DD72-3-HC

DIRECT DRAW BEER DISPENSER REFRIGERATORS

- Beautiful ergonomic appearance
- Digital Controller with Temperature Read-out
- Black corrosion resistant steel exterior, stainless steel interior and stainless steel top
- Forced air refrigeration system
- Air tubes to refrigerate beer towers
- Side mount compressor
- Recessed door handles
- (4) leveling feet included
- Accessory: optional casters upon request
- All Natural R290 Hydrocarbon Refrigerant
- US Department of Energy Certified
- Migali® Protection Plan: 1 Year Parts & Labor Warranty, 5 Years Compressor Warranty

MODEL	DOORS	CAPACITY CU/FT	1/2 BARREL KEG CAPACITY*	BEER TOWERS INCLUDED	H/P	AMPS	VOLTAGE	PLUG TYPE	TEMP RANGE	EXTERIOR DIMENSIONS W X D X H*	INSIDE DIMENSIONS W X D X H	PACKAGED DIMENSIONS W X D X H	WEIGHT	PACKAGED WEIGHT
C-DD23-1-HC	1	7	1	(1) single head	1/6+	1.7	115/60/0	Nema 5-15P	+33° F (~) +41° F	23.5" x 30.5" x 35.875"	19.63" x 19" x 31"	27" x 34" x 42"	143 lbs.	187 lbs.
C-DD48-2-HC	2	11.8	2	(1) single head	1/3	6.4	115/60/1	Nema 5-15P	+33° F (~) +41° F	48.75" x 24.4" x 35.875"	36" x 20.13" x 31"	51" x 27" x 39"	325 lbs.	355 lbs.
C-DD60-2-HC	2	15.8	2	(2) single head	1/3	6.4	115/60/1	Nema 5-15P	+33° F (~) +41° F	60.8" x 24.4" x 35.875"	48" x 20.13" x 31"	63" x 27" x 39"	394 lbs.	421 lbs.
C-DD72-3-HC	3	19.6	3	(2) single head	1/3	7.4	115/60/1	Nema 5-15P	+33° F (~) +41° F	72.8" x 24.4" x 35.875"	60" x 20.13" x 31"	75" x 27" x 39"	423 lbs.	456 lbs.

* More combinations of keg types on spec sheet
 ** Height does not include draft tower

Accessories:

- Dual Head Beer Tower (includes beer line and sanky)
- Dual Head beer Tower CO2 gas tank and regulator are not included

NOTE: MIGALI® RESERVES THE RIGHT TO CHANGE SPECIFICATIONS WITHOUT NOTICE



TOLL FREE: 800.852.5292
 WEB: www.migali.com



DIMENSIONAL DRAWINGS

C-DD23-1-HC

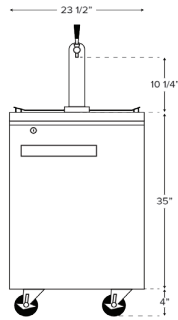

C-DD48-2-HC

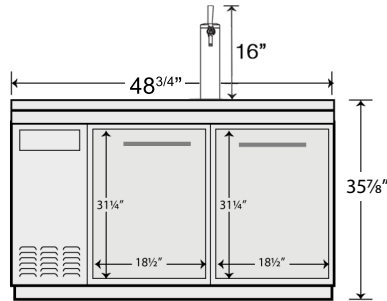

C-DD60-2-HC

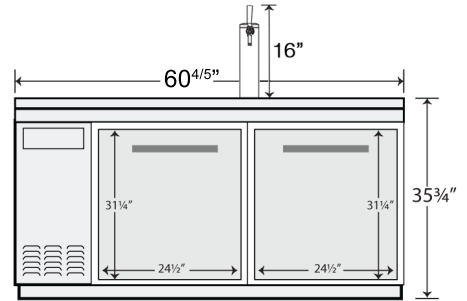

**C-DD23-1-HC
TOP VIEW**

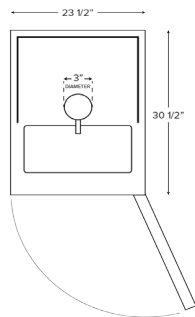

**C-DD48-2-HC
TOP VIEW**

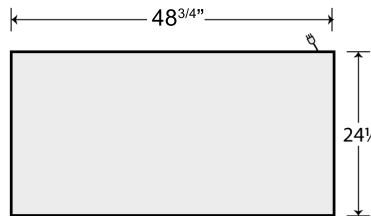

**C-DD60-2-HC
TOP VIEW**

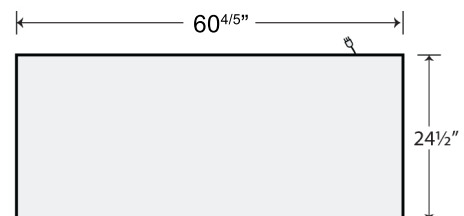

C-DD72-3-HC

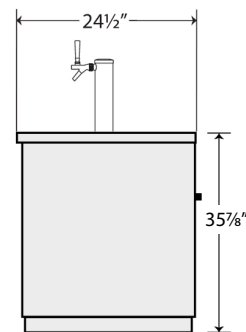
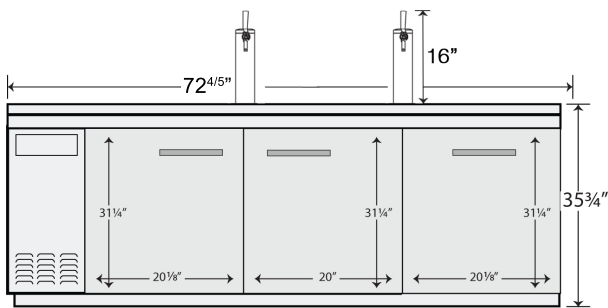

C-DD72-3-HC TOP VIEW

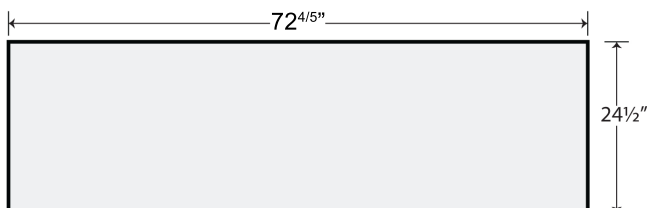

SIDE VIEW (1,2,3) DOOR MODELS



MIGALI® REMAINS AN AMERICAN FAMILY COMPANY SINCE 1955

INSIDE CAPACITY FOR THE C-DD-23-1-HC

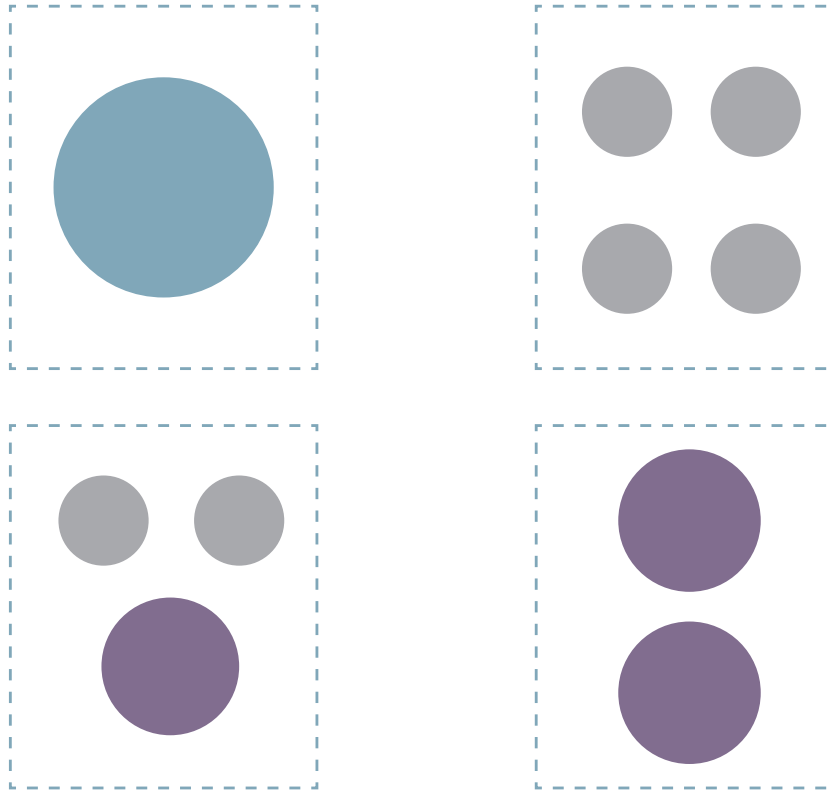

KEG SIZE COLOR KEY

	STANDARD HALF KEG
	1/4 SLIM KEG
	1/6 KEG





Migali®

COMPETITOR SERIES®

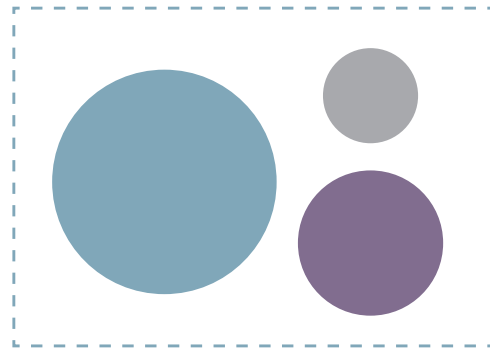
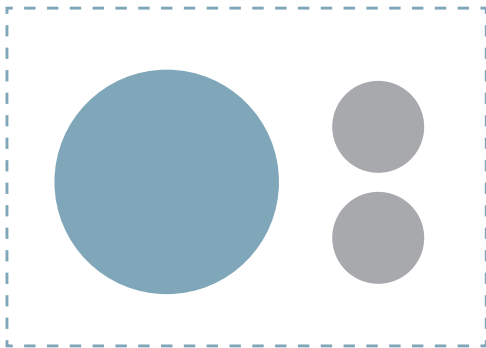
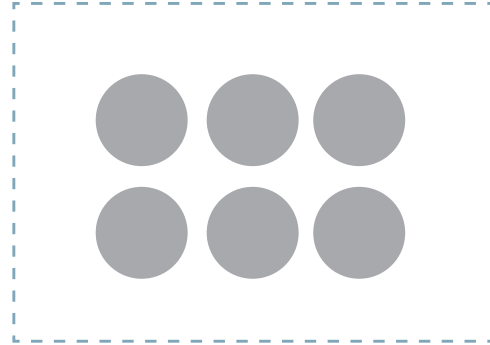
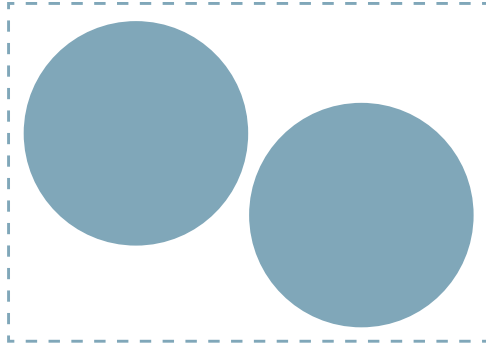
INSIDE CAPACITY FOR THE C-DD-48-2-HC



KEG SIZE COLOR KEY

-  STANDARD HALF KEG
-  1/4 SLIM KEG
-  1/6 KEG

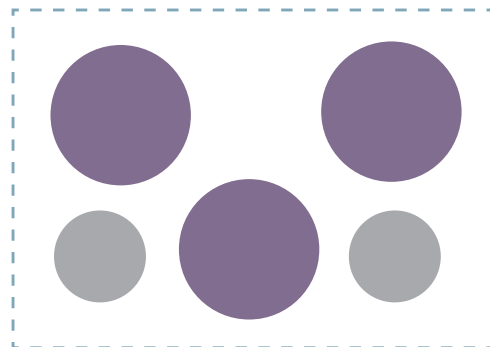

TOLL FREE: 800.852.5292
WEB: www.migali.com



Complies to NSF 7 Foodservice







Migali®

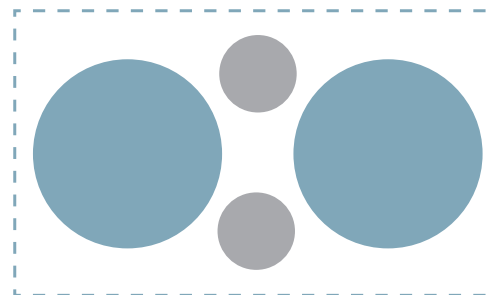
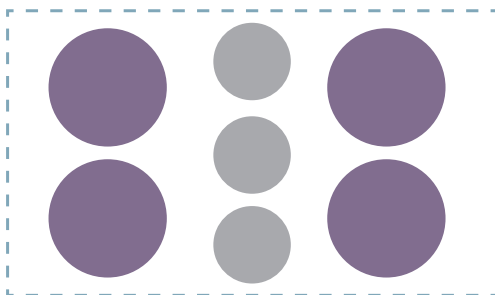
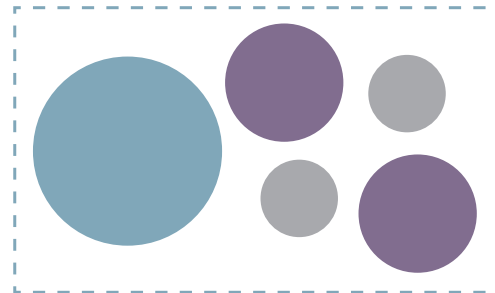
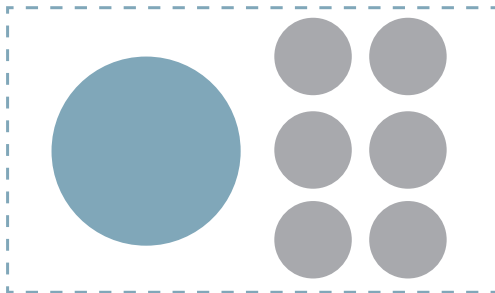
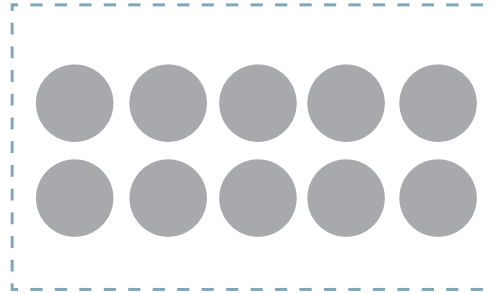
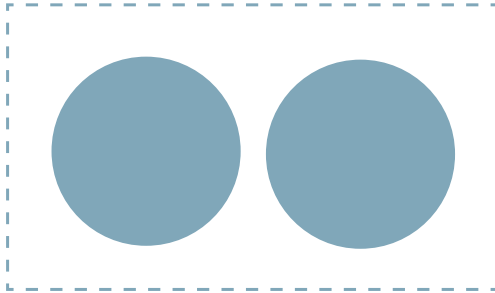

COMPETITOR SERIES® INSIDE CAPACITY FOR THE C-DD-60-2-HC

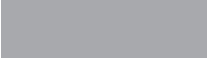

KEG SIZE COLOR KEY

	STANDARD HALF KEG
	1/4 SLIM KEG
	1/6 KEG

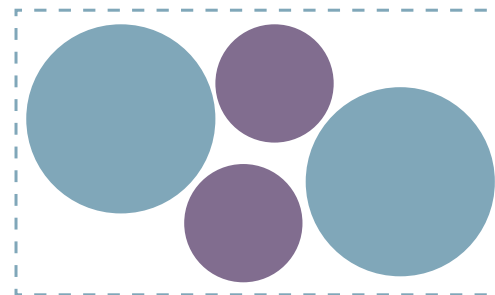

TOLL FREE: 800.852.5292
WEB: www.migali.com



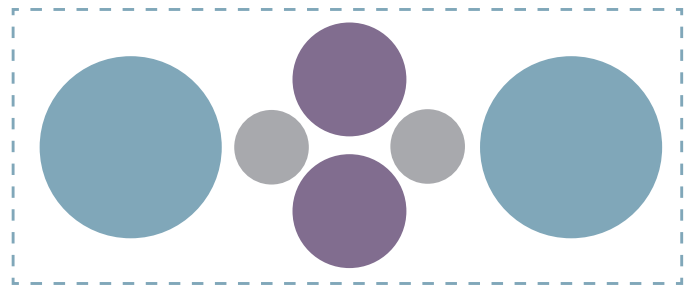
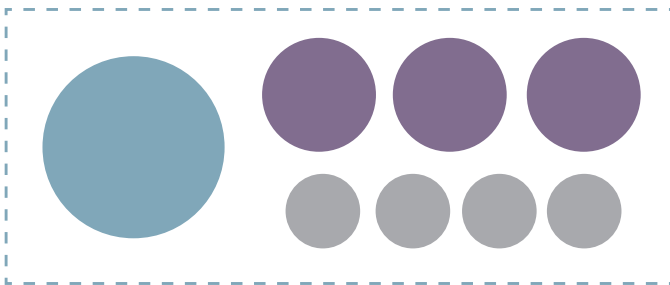
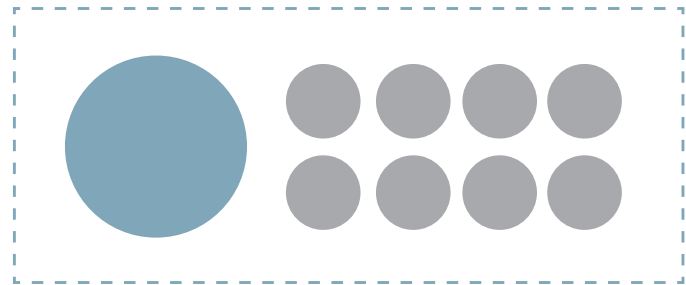
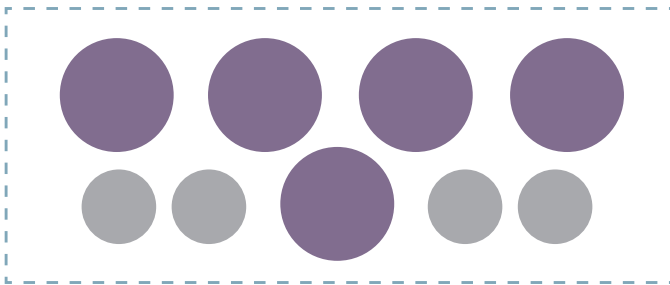
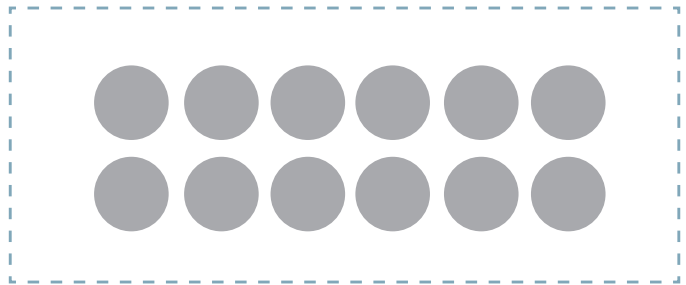
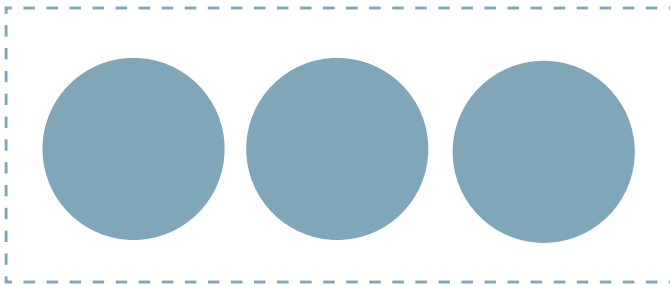

COMPETITOR SERIES®

INSIDE CAPACITY FOR THE C-DD-72-3-HC



KEG SIZE COLOR KEY

	STANDARD HALF KEG
	1/4 SLIM KEG
	1/6 KEG