

**GRIDDLES & BROILERS****VULCAN****VICM SERIES  
GAS INFRARED CHEESEMELTER**

Model VICM36

**SPECIFICATIONS**

Gas infrared cheesemelter, Vulcan-Hart Model No. \_\_\_\_\_.  
Stainless steel front, top, bottom and sides. Welded stainless and aluminized steel chassis. Equipped with heavy-duty pre-mix atmospheric infrared burners. Standing pilot ignition system. Heavy-duty chrome plated grid rack and 3 position rack guide. Removable full width spillage pans. Wall mounting brackets. 3/4" rear gas connection and gas pressure regulator. One year limited parts and labor warranty.

CSA Design Certified. NSF Certified.

**SPECIFY TYPE OF GAS WHEN ORDERING.  
SPECIFY ALTITUDE WHEN ABOVE 3,999 FT.**

- VICM24** 24" cheesemelter broiler
- VICM36** 36" cheesemelter broiler
- VICM48** 48" cheesemelter broiler
- VICM60** 60" cheesemelter broiler
- VICM72** 72" cheesemelter broiler

**STANDARD FEATURES**

- Stainless steel front, top, bottom and sides.
- Welded stainless and aluminized steel chassis.
- Equipped with heavy-duty pre-mix atmospheric infrared burners.
- Standing pilot ignition system.
- Heavy-duty chrome plated grid rack and 3 position rack guide.
- Removable full width spillage pans.
- Wall mounting brackets.
- 3/4" rear gas connection and gas pressure regulator.
- One year limited parts and labor warranty.

**OPTIONS**

- Pilot safety valve for each burner. Safety will completely shut off gas to pilot and burners if pilot extinguishes.
- 4" chrome plated legs with adjustable feet.
- Pass through models.

**VULCAN**

a division of ITW Food Equipment Group LLC

P.O. Box 696 ■ Louisville, KY 40201 ■ Toll-free: 1-800-814-2028 ■ Local: 502-778-2791 ■ Quote &amp; Order Fax: 1-800-444-0602



**VICM SERIES  
GAS INFRARED CHEESEMELTER**

**INSTALLATION REQUIREMENTS:**

1. A gas pressure regulator supplied with the unit must be installed. Natural Gas 5.0" (127 mm) W.C. Propane Gas 10.0" (254 mm) W.C.
2. Gas line connecting to appliance must be 3/4" diameter or larger. If flexible connectors are used, the inside diameter must be the same as the 3/4" iron pipe.
3. An adequate ventilation system is required for Commercial Cooking Equipment (NFPA No. 96). Information may be obtained by writing to the National Fire Protection Association, Batterymarch Park, Quincy, MA 02169.
4. These units are manufactured for installation in accordance with National Fuel Gas Code, ANSI-Z223.1/NFPA #54 (latest edition). Copies may be obtained from The American Gas Association, Accredited Standards Committee Z223 @ 400 N. Capital St. NW,

Washington, DC 20001, or the Secretary Standards Council, NFPA, 1 Batterymarch Park, Quincy, MA 02169-7471.

**NOTE: In The Commonwealth of Massachusetts**

All gas appliances vented through ventilation hood or exhaust system equipped with a damper or with a power means of exhaust shall comply with 248 CMR.

- |                |             |                 |
|----------------|-------------|-----------------|
| 5. Clearances: | Combustible | Non-Combustible |
| Rear           | 2"          | 0"              |
| Sides          | 20"         | 0"              |
| Bottom         | 10"         | 4"              |
6. This appliance is manufactured for commercial installation only and is not intended for home use.

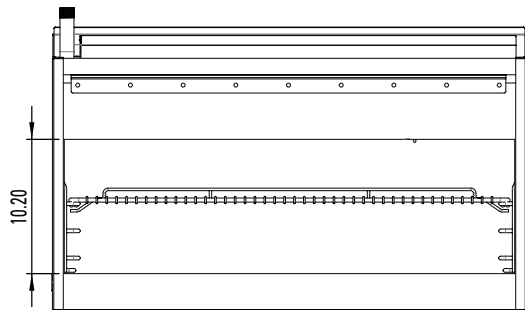
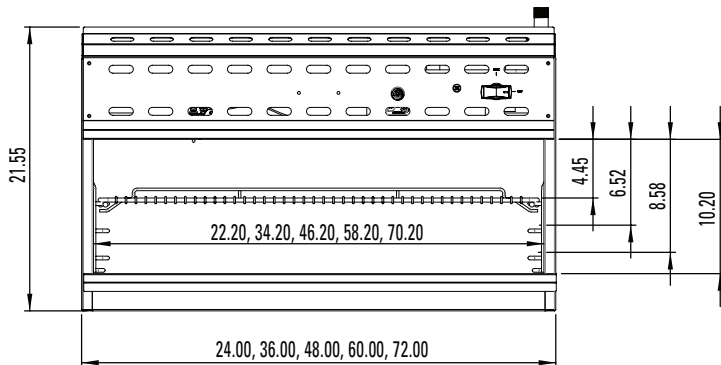
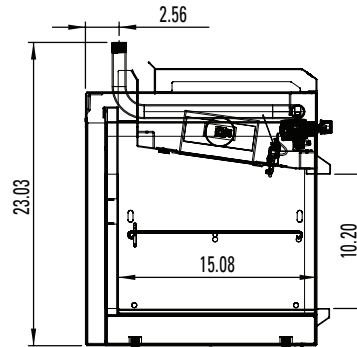
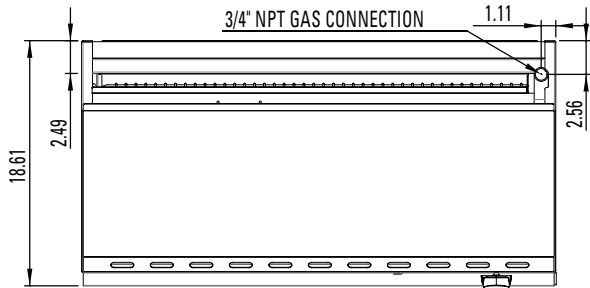

REAR VIEW - PASS THROUGH MODELS

MODEL	WIDTH	DEPTH	OVERALL HEIGHT*	INTERIOR DIMENSIONS (W x D x H)	NO. OF BURNERS	TOTAL BTU/HR	NO. OF PANS	APPROX. SHIP. WT.
VICM24	24"	18.61"	23.03"	22.20" x 15.08" x 10.20"	1	20,000	1	140 lbs./64 kg
VICM36	36"	18.61"	23.03"	34.20" x 15.08" x 10.20"	1	30,000	1	185 lbs./84 kg
VICM48	48"	18.61"	23.03"	46.20" x 15.08" x 10.20"	2	40,000	2	240 lbs./109 kg
VICM60	60"	18.61"	23.03"	58.20" x 15.08" x 10.20"	2	50,000	2	285 lbs./129 kg
VICM72	72"	18.61"	23.03"	70.20" x 15.08" x 10.20"	2	60,000	2	340 lbs./154 kg

\*These are nominal dimensions and can vary by +5.75" with adjustable legs.



a division of ITW Food Equipment Group LLC

P.O. Box 696 ■ Louisville, KY 40201 ■ Toll-free: 1-800-814-2028 ■ Local: 502-778-2791 ■ Quote & Order Fax: 1-800-444-0602

**NOTE:** In line with its policy to continually improve its products, Vulcan reserves the right to change materials and specifications without notice.