

- KD-0350A
- KY-0350A
- KD-0350W
- KY-0350W

K-0350 Ice Kube Machine



- Easy access to food zone with removal of two screws and lift-off door
- High-tech exterior with smudge and fingerprint resistant stainless-like finish
- White plastics in the food zone help identify areas needing cleaning
- Water shield, distribution tube, pump, floats, and trough removable by hand
- Available CleanAir™ pack controls the growth of bacteria and fungi that form slime and cause odors in the food zone

WARRANTY:

Ice Maker: 3 year Parts & Labor
 Evaporator: 5 year Parts & Labor
 Compressor: 5 year Parts & 3 year Labor



HALF KUBE

$\frac{3}{8}'' \times 1\frac{1}{8}'' \times \frac{7}{8}''$
 (.95 x 2.86 x 2.22 cm)

= 100%



KUBE

$\frac{7}{8}'' \times \frac{7}{8}'' \times \frac{7}{8}''$
 (2.22 x 2.22 x 2.22 cm)

= 100%

R410A Refrigerant



K-0350
ICE KUBE MACHINE















KOOLAIRE®

by **Manitowoc**







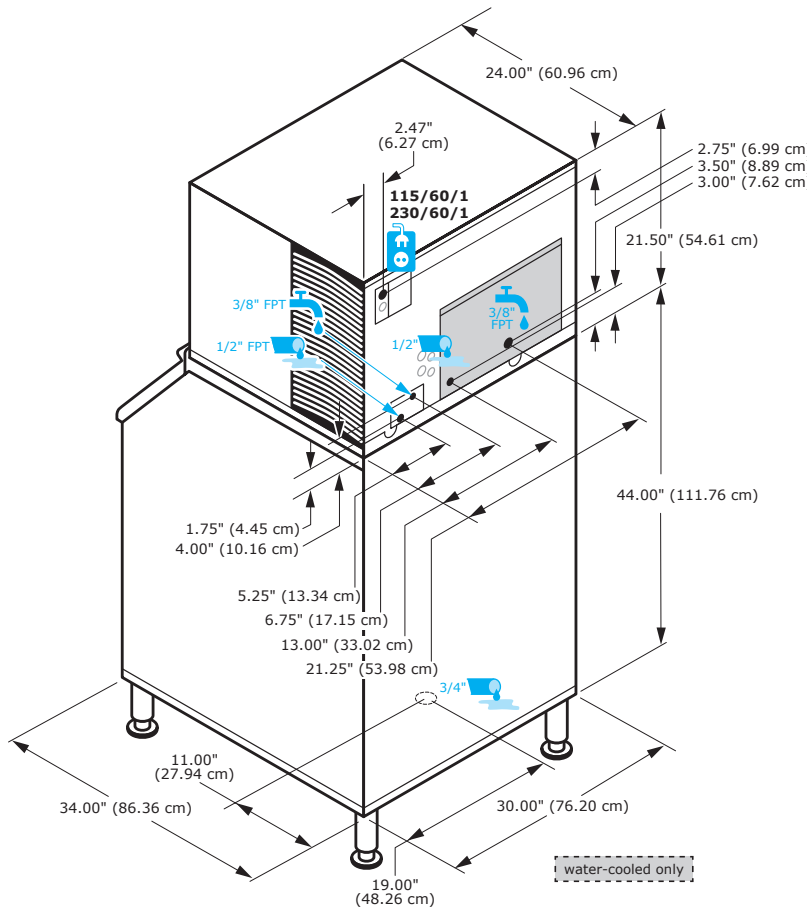

2110 SOUTH 26TH ST | MANITOWOC, WI 54220 USA | 1-920-682-0161 [www.kool-aire.com]



K-0350 ICE KUBE MACHINE

				24h   			
				70°/50° F 21°/10° C	90°/70° F 32°/21° C	[kWh/ 100 lbs ice]	[gal/100 lbs ice]
KD-0350A			375 lbs	300 lbs	6.2	22.0	
			170 kg	136 kg			
KY-0350A			400 lbs	320 lbs	6.2	22.0	
			181 kg	145 kg			
KD-0350W			381 lbs	305 lbs	5.2	22.0	
			173 kg	138 kg			
KY-0350W			388 lbs	310 lbs	5.2	22.0	
			176 kg	141 kg			



Minimum		Maximum
35°F 1.7°C		110°F 43.3°C
35°F 1.7°C		90°F 32.2°C
20psi 138 kPa		80psi 551 kPa
12.1 11.4		A
		20 Amps
153 lbs 69 kg		
147 lbs 67 kg		

KOOLAIRE®

by **Manitowoc**

2110 SOUTH 26TH ST | MANITOWOC, WI 54220 USA | 1-920-682-0161 [www.kool-aire.com]