

**HOBART**701 S Ridge Avenue, Troy, OH 45374  
1-888-4HOBART • www.hobartcorp.com**LT-1  
DISHWASHER****LT-1 LOW-TEMP  
CHEMICAL  
DISHWASHER**

- All stainless steel construction including tank, chamber, doors, and frames.
- 37 Racks/Hr. - 1.7 Gal./Rack 140°F water usage.
- Field adjustable from straight to corner operation.
- Door cycle switch controls machine operation.
- Filling machine initially – auto fill after first cycle – Fill time field adjustable.
- All doors raise and close together and are guided for ease of operation.
- Solenoid operated positive seating drain valve - open and closed. No water waste.
- Long life detergent - sanitizer - rinse additive pumps supplied mounted in control center.
- High pressure - All stainless steel revolving, interchangeable upper, and lower ball bearing wash/rinse arms.
- ¾ H.P.- 3450 RPM Pump Motor - 45 GPM.
- 120/60/1 Electrical Specification.
- Self-flushing stainless steel pump strainer. Large scrap accumulator.
- Exclusive de-liming cycle.

Specifications, Details and Dimensions on Reverse Side.

**Shown with Optional  
Front Panel**

# LT-1 DISHWASHER

**HOBART**

701 S Ridge Avenue, Troy, OH 45374  
1-888-4HOBART • www.hobartcorp.com

**SPECIFICATIONS:** Listed by Underwriters Laboratories Inc and National Sanitation Foundation.

Model LT-1 low temperature (140°F) fill and dump dishwasher is delivered for straight thru operation. Three door lift design can be easily converted to a corner operation at installation. Standard electrical voltage specification is 120/60/1. No racks are shipped with machine.

**\*CAUTION:** Certain materials, including silver, aluminum, and pewter are attacked by sodium hypochlorite (liquid bleach).

**CONSTRUCTION:** Tank, doors, chamber, and sump constructed of 16 ga. stainless steel, heliarc welded. Frame constructed of 12 ga. and 16 ga. stainless steel.

**DOOR LIFT:** All three doors coupled by chrome plated handle and spring counter-balanced. All doors guided for ease of operation and long life.

**PUMP:** Integral with  $\frac{3}{4}$  H.P. motor assures alignment and quiet operation. Pump shaft seal with stainless steel parts and a carbon ceramic sealing interface. Pump capacity is 45 gpm.

**CONTROL SYSTEM:** Top mounted control box features an on/off switch, drain/fill switch, cycle light, counter and de-liming switch for cleaning. Control box also contains three peristaltic pumps with individual priming switches to automatically inject correct amount of chemicals in the machine each cycle.

**CYCLE OPERATION:** Closing the doors starts the wash cycle thru door cycle switch. During wash cycle, detergent is injected into machine. After wash cycle, machine empties the wash water into the external scrap accumulator while the flush cycle flushes the wash systems and pump of any remaining detergent. The machine then fills for the rinse/sanitizer portion of the cycle. During the rinse cycle, wetting agent, and sanitizer are pumped into the machine. At the end of the rinse cycle, the cycle is complete. The rinse water is

retained for the next wash cycle. If the cycle is interrupted, the cycle will continue from time of interruption and complete the cycle.

Wash	40 seconds
Drain	10 seconds
Flush	3 seconds
Fill	9 seconds
Rinse	20 seconds

**RACK CAPACITY:**  
40 Racks/hr

**WASH AND RINSE:** Revolving stainless steel ball bearing wash/rinse arms above and below provide thorough distribution of water jets to all dishware surfaces. Arms are easily removable for cleaning and are interchangeable. Stainless steel tubing connects upper and lower systems.

**FILL:** Incoming water passes through large capacity line strainer and is controlled by solenoid operated fill valve on upstream side of vacuum breaker. Fill activates flushing of the entire system each cycle. The fill time gives the correct amount of water per cycle when the inlet pressure is 15 to 25 psig.

**OVERFLOW:** Automatic overflow built into drain tube and directed to external scrap strainer pan.

**DRAIN:** Solenoid operated drain stopper automatically empties the dishwasher each cycle. Drain stopper is large diameter, high temperature material engineered to provide free flush drain.

**STRAINER SYSTEM:** Equipped with self-flushing, removable, perforated stainless steel, inside pump strainer, and large capacity, easily cleanable, outside, perforated stainless steel strainer pan.

**OPTIONAL EQUIPMENT AT EXTRA COST:** Stainless steel front panel. Removable without the use of tools.

**ACCESSORIES:** Peg and combination racks can be furnished at added cost.

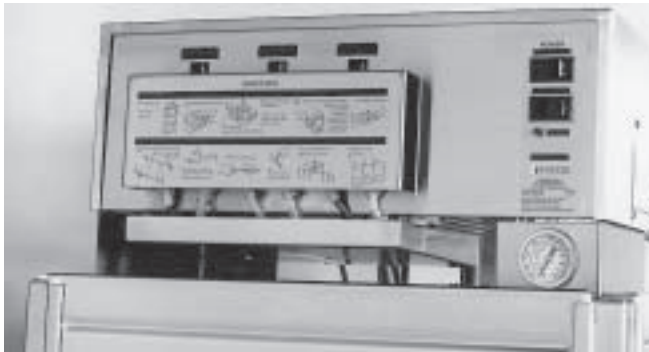

**CONTROL PANEL:** Top-mounted control box features an on/off switch, drain/fill switch, cycle light, visual chemical dispensing counter and de-liming switch for cleaning.

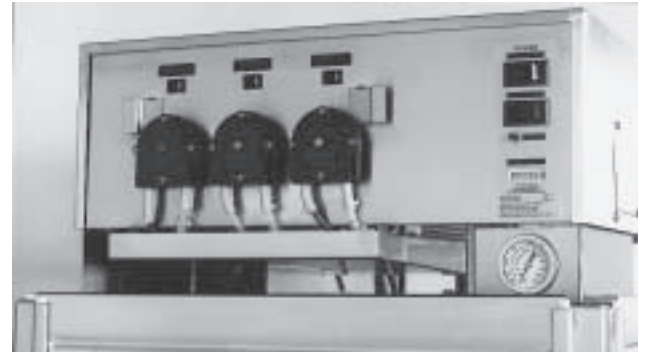

**DISPENSING PUMPS:** Under the easily removable pump are three peristaltic pumps that dispense detergent, sanitizer and rinse aid.

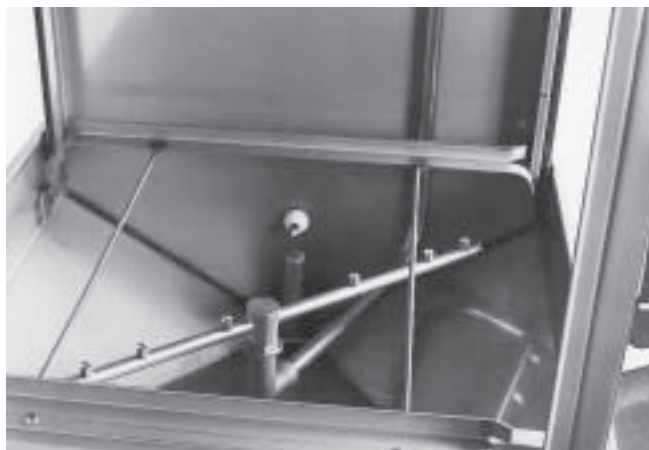

**UPPER AND LOWER WASH/RINSE ARMS:** All stainless steel and interchangeable. Stainless steel tubing connects upper and lower systems. Easily removable without the use of tools for ease of cleaning. Provides thorough distribution of water to all surfaces.

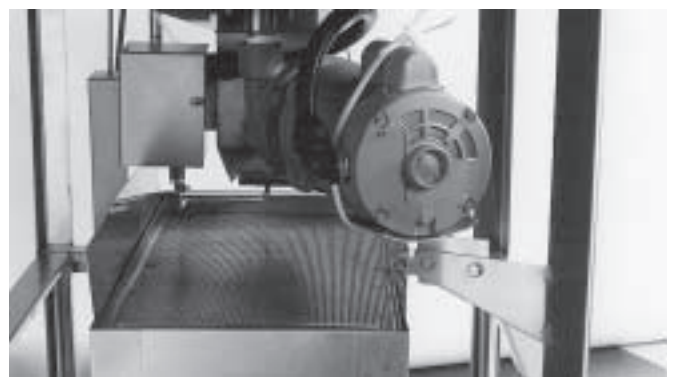

**EXTERNAL STRAINER PAN:** Conveniently located for operator inspection and cleaning. All stainless steel construction.

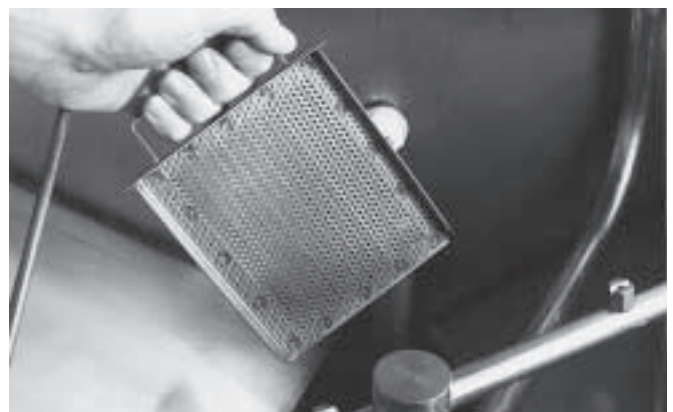

**PUMP STRAINER:** Self-flushing, perforated stainless steel.

# LT-1 DISHWASHER

# HOBART

701 S Ridge Avenue, Troy, OH 45374  
1-888-4HOBART • www.hobartcorp.com

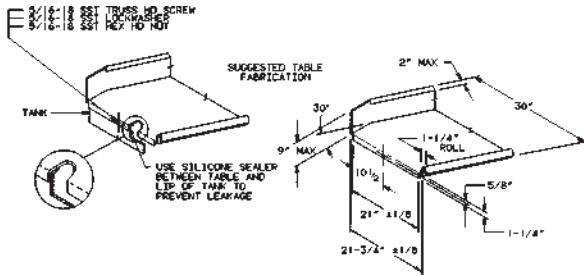

## DETAILS AND CONNECTIONS

### LT-1 STRAIGHT THROUGH & CORNER

- ① SINGLE FILL & RINSE CONNECTION - 3/4" FEMALE THREAD  
RECOMMENDED WATER TEMP. 140°F (120°F MIN)  
REQUIRED BUILDING FLOWING WATER PRESSURE TO THE DISHWASHER IS 10-25 PSIG. IF PRESSURE IS HIGHER THAN 25 PSIG, A PRESSURE REGULATING VALVE MUST BE SUPPLIED (BY OTHERS) IN THE WATER LINE TO THE DISHWASHER. RECOMMENDED WATER HARDNESS TO BE 2 1/2 GRAINS FOR BEST RESULTS.
- ② DRAIN PIPE CONNECTION - 2" MALE THREAD
- ③ ELECTRICAL CONNECTION - KNOCKOUT FOR 1/2" CONDUIT  
SUPPLY VOLTAGE - 120/60/1  
RATED AMPS - 14.0  
MINIMUM SUPPLY CIRCUIT CONDUCTOR CAPACITY - 20  
MAXIMUM TIME DELAY FUSE - 20

SIZE OF RACKS - 19-3/4" X 19-3/4"  
3/4 H.P. MOTOR  
ALL DIMENSIONS TAKEN FROM FLOOR LINE MAY INCREASE 1" OR DECREASE 1/2" DEPENDING ON LEG ADJUSTMENT

NOTE WATER HAMMER ARRESTOR (MEETING ASSE-1010 STANDARD OR EQUIVALENT) TO BE SUPPLIED (BY OTHERS) IN WATER SUPPLY LINE AT SERVICE CONNECTION

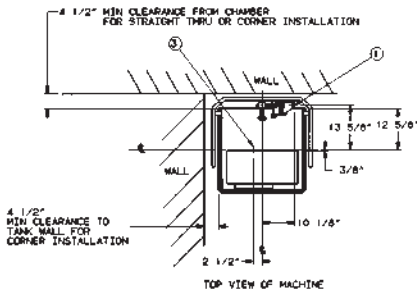

TOP VIEW OF MACHINE

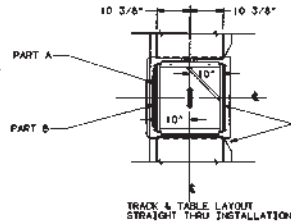

TRACK & TABLE LAYOUT STRAIGHT THRU INSTALLATION

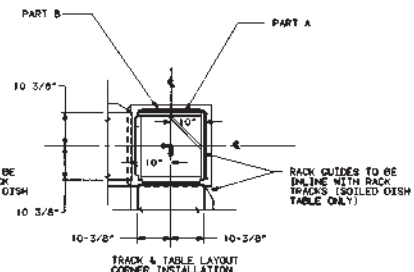

TRACK & TABLE LAYOUT CORNER INSTALLATION

RACK GUIDES TO BE IN LINE WITH RACK TRACKS (SOILED DISH TABLE ONLY)

RACK GUIDES TO BE IN LINE WITH RACK TRACKS (SOILED DISH TABLE ONLY)

NOTE CORNER CONVERSION IS ACCOMPLISHED BY MOVING PARTS A, B & FASTENERS FROM STRAIGHT THRU INSTALLATION POSITION TO CORNER INSTALLATION POSITION AS SHOWN ABOVE.

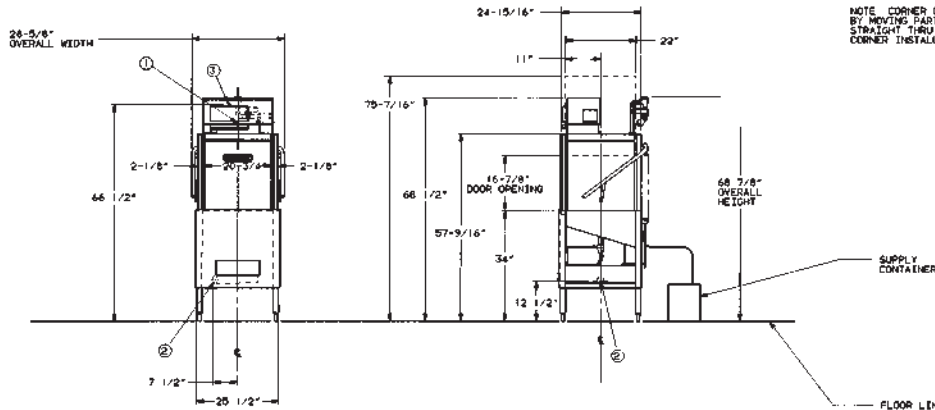

### WARNING

PLUMBING CONNECTIONS MUST COMPLY WITH APPLICABLE SANITARY, SAFETY AND PLUMBING CODES IN FORCE

### WARNING

ELECTRICAL AND GROUNDING CONNECTIONS MUST COMPLY WITH THE APPLICABLE PORTIONS OF THE NATIONAL ELECTRICAL CODE AND/OR OTHER LOCAL ELECTRICAL CODES.

NET WEIGHT OF MACHINE = 239 LBS.  
DOMESTIC SHIPPING WEIGHT = 304 LBS.

As continued product improvement is a policy of Hobart, specifications are subject to change without notice.

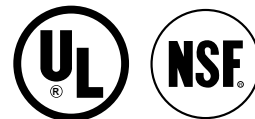

# HOBART

CORPORATION

701 RIDGE AVENUE  
TROY, OHIO 45374-0001

LITHO IN U.S.A. (H-01)

Printed On Recycled Paper