

BLACK◆DIAMOND

Gas Deep Fryers - BDGF Series

Black Diamond's floor standing gas deep fryers are constructed with a 16 gauge stainless steel tank and have a thermostat range of 200°F (93°C) to 400°F (204°C). Long lasting baffles are mounted in the heat exchange tubes to provide maximum heating and combustion efficiency. A standing pilot light design provides a ready flame when heat is required and an automatic shut off function when the fryer temperature exceeds 450°F (232°C).



BDGF-90/NG
BDGF-90/LPG
BDGF-120/NG
BDGF-120/LPG

BDGF-150/NG
BDGF-150/LPG



Construction

- ◆ Welded 16 gauge stainless steel tank with a super smooth machine finish ensures easy cleaning
- ◆ Long lasting baffles are mounted in the heat exchange tubes to provide maximum heating and combustion efficiency
- ◆ Standing pilot light design provides a ready flame when heat is required
- ◆ Cabinet is constructed with a stainless steel front and door with galvanized sides and back

Controls

- ◆ Thermostat maintains temperature between 200° (93°C) and 400°F (204°C)
- ◆ Integrated gas control valve acts as a manual and pilot valve, automatic pilot valve, gas filter, pressure regulator and automatic main valve
- ◆ Gas control valve prevents gas flow to the main burner until pilot is established and shuts off gas flow automatically if the pilot flame goes out
- ◆ Temperature limit automatically shuts off all gas flow if the fryer temperature exceeds 450°F (232°C)
- ◆ Includes Robert Shaw components that are made in the USA

Operations

- ◆ Standing pilot and thermostat maintain temperature automatically at the selected temperature (between 200°F (93°C) and 400°F (204°C))
- ◆ Front 1-1/4" drain for quick draining

Standard Accessories

- ◆ Two nickel plated oblong wire mesh baskets
- ◆ One nickel plated tube rack
- ◆ One drain extension
- ◆ Built-in heat deflector
- ◆ 6" adjustable legs

Available Accessories (Sold Separately)

- ◆ Stainless Steel Cover
- ◆ Casters
- ◆ Joiner Strips
- ◆ Splash Guard

Conforms to ANSI
STD Z83.11b-2009
Certified to CSA
STD 1.8b-2009



Intertek

Black Diamond warrants to the original user of its gas fryers and related equipment that said appliances and related equipment will be free from defects in material and workmanship under normal use for a period of one (1) year from the date of installation, with appropriate documentation. Should your equipment fail within this time, upon approval, parts and labor charges will be covered by this warranty. The stainless steel fry tank has a five (5) year limited tank warranty. If during the first year only, the tank is found to have a leak and is verified by an authorized service company, the entire fryer will be replaced. After the first year a replacement tank will be sent free of charge excluding freight and labor charges.

BLACK◆DIAMOND

Gas Deep Fryers - BDGF Series

Plan View

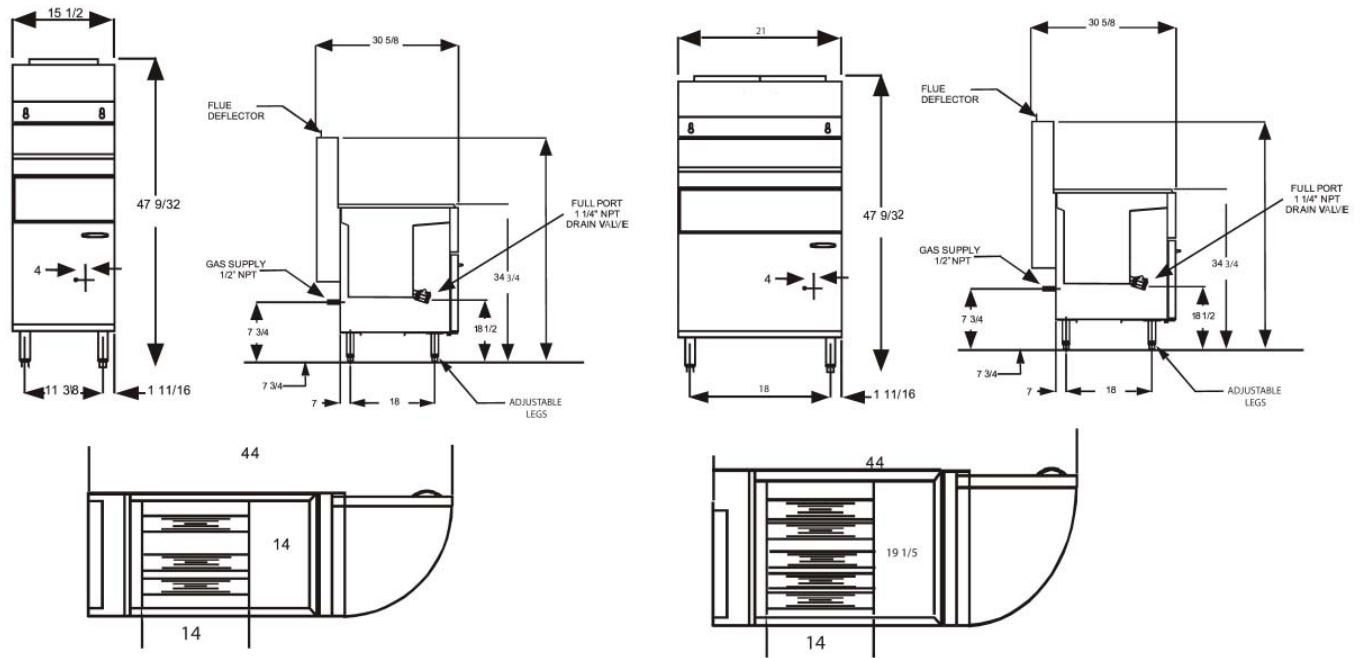

BDGF-90 and BDGF-120

BDGF-150

Specifications

Model Number	BTU	Net Weight (lb)	Gross Weight (lb)	Oil Capacity (lb)
BDGF-90/NG	90,000	152 (69kg)	169 (77kg)	35-40 (18.5-23 L)
BDGF-90/LPG	90,000	152 (69kg)	169 (77kg)	35-40 (18.5-23 L)
BDGF-120/NG	120,000	163 (74kg)	180 (82kg)	45-50 (21.3-25 L)
BDGF-120/LPG	120,000	163 (74kg)	180 (82kg)	45-50 (21.3-25 L)
BDGF-150/NG	150,000	198.5 (90kg)	218 (99kg)	65-70 (31-37 L)
BDGF-150/LPG	150,000	198.5 (90kg)	218 (99kg)	65-70 (31-37 L)

Shipping Info

Model Number	Cubic Feet	Dimensions (in)*
BDGF-90/NG	15.9 (0.45 cubic meters)	53 1/2"H x 15 1/2"W x 30 1/4"D
BDGF-90/LPG	15.9 (0.45 cubic meters)	53 1/2"H x 15 1/2"W x 30 1/4"D
BDGF-120/NG	15.9 (0.45 cubic meters)	53 1/2"H x 15 1/2"W x 30 1/4"D
BDGF-120/LPG	15.9 (0.45 cubic meters)	53 1/2"H x 15 1/2"W x 30 1/4"D
BDGF-150/NG	20.5 (0.58 cubic meters)	53 1/2"H x 21"W x 30 1/4"D
BDGF-150/LPG	20.5 (0.58 cubic meters)	53 1/2"H x 21"W x 30 1/4"D

*Height is with legs set at 6"